

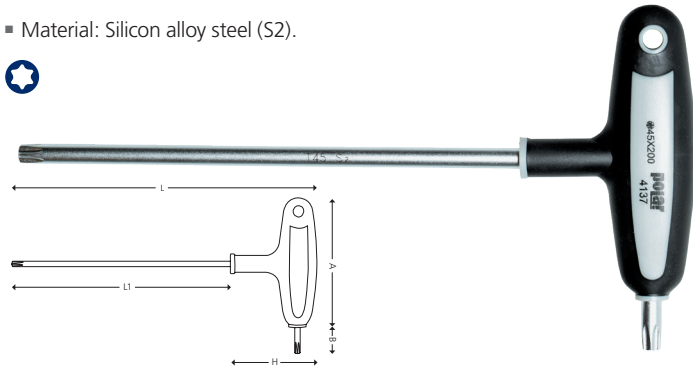

4137 T-HANDLE TORX® SCREWDRIVERS

Material: Silicon alloy steel (S2).



ITEM NO.	5704196+	TORX® NO.	MM	A MM	B MM	H MM	L MM	L1 MM	G	
4137-0008	028699	TX 8	2,31	90	18	60	160	100	45	10
4137-0010	028712	TX 10	2,74	90	18	60	160	100	53	10
4137-0015	028729	TX 15	3,27	90	18	60	160	100	53	10
4137-0020	028736	TX 20	3,86	90	18	60	160	100	53	10
4137-0025	028743	TX 25	4,43	90	18	60	210	150	71	10
4137-0027	028750	TX 27	4,99	90	18	60	210	150	72	10
4137-0030	028774	TX 30	5,52	90	18	60	210	150	88	10
4137-0040	028781	TX 40	6,65	115	20	68	268	200	148	10
4137-0045	028798	TX 45	7,82	115	20	68	268	200	176	10
4137-0050	028804	TX 50	8,83	115	20	68	268	200	208	10

4142 T-HANDLE SCREWDRIVERS - HEX NUTSPINNER

DIN 3125

Material: Chrome-vanadium steel.

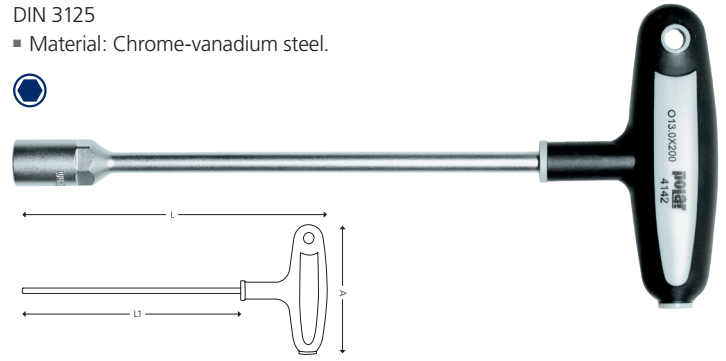

ITEM NO.	5704196+	SIZE MM	A MM	H MM	L MM	L1 MM	G	
4142-0005	028309	5	115	68	268	200	104	10
4142-0055	028316	5,5	115	68	268	200	106	10
4142-0006	028323	6	115	68	268	200	121	10
4142-0007	028330	7	115	68	268	200	119	10
4142-0008	028347	8	115	68	268	200	143	10
4142-0009	028354	9	115	68	268	200	146	10
4142-0010	028361	10	115	68	268	200	171	10
4142-0011	028387	11	115	68	268	200	178	10
4142-0012	028385	12	115	68	268	200	178	10
4142-0013	028392	13	115	68	268	200	182	10
4142-0014	028408	14	115	68	268	200	182	10
4142-0017	028415	17	115	68	268	200	208	10

4197 T-HANDLE SCREWDRIVER SET - TORX®

Supplied in practical holder.



ITEM NO.	5704196+	QTY.	SIZE MM	G	
4197-1008	028804	8	T10 - T15 - T20 - T25 - T30 - T40 - T45 - T50	1150	10